

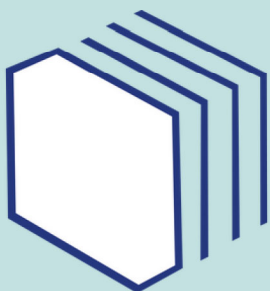

Standardizing Modularity for Industrial PCs

ModBlox7™

Standard expected to be released early 2023



ModBlox7



The Need for Industrial PCs

As some market observations confirm (e.g. study by Markets & Markets Research), the demand for industrial PCs is unabashedly high and will continue to grow over the next few years. No wonder - industrial PCs are used in a wide range of state-of-the-art applications such as industrial automation, AI, IIoT, cloud and edge computing.

Currently there is an almost uncountable number of different manufacturers with equally different products in terms of performance, interfaces, market qualification, and mechanics. These are often proprietary within their own product family. Customers therefore opt for a specific product for many years, binding themselves to a single manufacturer.

Growing Market Size

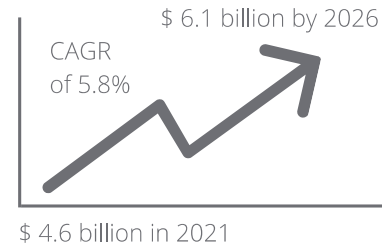

Source: Markets & Markets

Widely Spread Applications

- Process & Control
- Communication
- Data Acquisition & Diagnosis
- Edge Computing & IIoT

Game Changer Standardizing Modular Industrial PCs

The increasing demand for space, cost and weight optimized industrial PCs combined with the lack of interoperability and flexibility of the current offering, formed the motivation for ModBlox7 (specification currently in development).

ModBlox7 combines the advantages of modular systems (e.g. CPCI) with highly integrated BoxPCs.

Based on a modular and flexible IPC system, every functionality unit like Power Supply, CPU and I/Os can be a multiple of 7 HP, forming an individual system (up to 12x 7 HP) while using cost-effective standard modules.

The system offers different mounting options like wall, DIN-Rail or 19" sub-rack and comes with standardized mechanical and electrical interconnection between units.

Thanks to the mechanical and electrical concept no additional expensive components like backplanes or shelf controllers are needed.

For high availability solutions redundant architectures can be easily realized.

Expandable Width

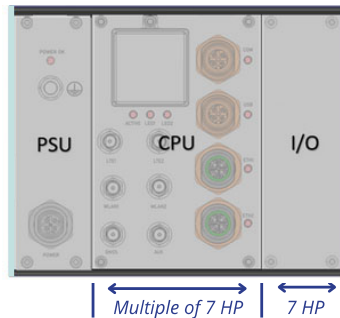

6 Slot (6x 7 HP)

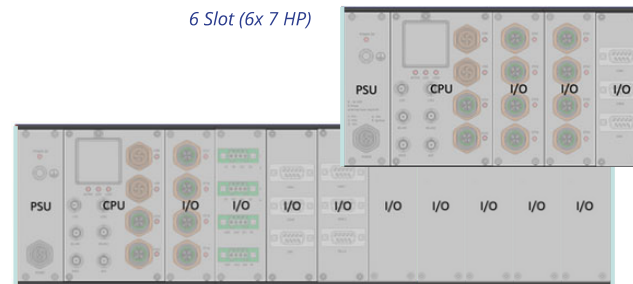

Up to 12 Slots possible (12x 7 HP; 84 HP)

Basic Architecture

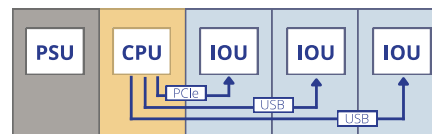

- USB3.0 & USB2.0 & PCIe as communication interfaces
- Each unit distributes all interfaces minus consumed ones to neighbor board

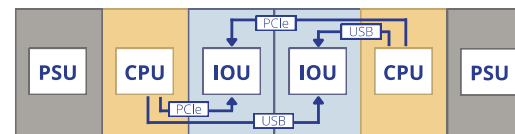

- Allows redundant architectures

Benefits

- Modular AND Cost Sensitive**
- Scalable at Lowest Space Requirements**
- Interoperability for Users & Manufactures**
- Fulfills Demands of Increasing IPC Market**
- Allows Tailoring also for Small Quantities**
- Only Pay for What You Need**

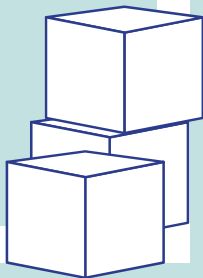

ModBlox7 Ecosystem

These manufacturers are developing the new ModBlox7 standard - and the list is still growing.

With the forced experience of all companies we will form a reliable and useful industrial PC standard.



Contact

Your company want to participate in the new ModBlox7 standard?

You have any further questions?

Please contact Jess Isquith from PICMG or the chairmen of the working group Bernd Kleeberg from EKF.



jess@picmg.org

kle@ekf.de